

Owner's Manual

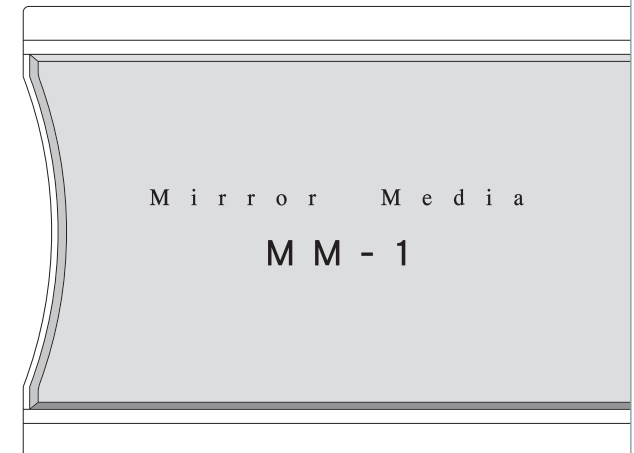

Thank you for purchasing this BEWITH Mirror Media MM-1. It is designed to give you many years of enjoyment.

- Please read all instructions in this manual before attempting operation and keep it handy for future references.
- Please make sure of the product's serial number, the date of purchase, and the dealer name on the enclosed warranty for your own security and convenience. Should you have any questions, contact your nearest BEWITH authorized dealer or installation specialist.

Precautions Please read carefully before using this product.

Please read all instructions in this manual before attempting operation and keep it handy for future references. We are not responsible for damage or any malfunctions caused by not following the instructions.

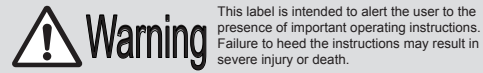

Warning for safe usage

- **The driver must not operate while driving.**
For your safety, some of the functions do not allow you to operate unless the vehicle is stopped and the parking brake is applied.
- **DO NOT watch the unit while driving.**
Proper installation allows the driver to only watch the screen when the vehicle is stopped and the parking brake is applied. (Except rearview camera)
- **DO NOT disassemble or modify the product as it may cause accident, fire or electrical shock.**
It will void your warranty.
- **DO NOT attempt to operate if screen fails or no sound is heard as it may cause accident, fire or electrical shock.**
Please contact the dealer or distributor from where you purchased the product for this matter.
- **Stop using the unit immediately when problems appear such as noxious odors or smoke being emitted from the unit, or foreign objects or dropped inside the unit.**
Please contact the dealer or distributor from where you purchased the product.
- **For your safety, please ask the dealer from where you purchased the product for installation and changing the system that need technical skill.**

Caution for safe usage

- **For traffic safety and to maintain safe driving conditions, keep the volume low enough so that you can still hear normal traffic sound.**
- **DO NOT use this unit for purposes other than those listed for a vehicle.**
- **DO NOT use benzine, paint thinner, or any other chemicals to clean this unit.**
Please use dry or wringed cloth.
- **DO NOT spray any cleaning fluid directly on this unit.**
Please spray and spread it on cloth and clean for preventing damage.

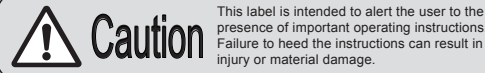

Warning for installation

- **This unit is for vehicles with a 12-volt battery and negative grounding.**
Before installing it in a recreational vehicle, truck or bus, check the battery voltage.
- **To prevent an electric shock or short-circuit during connection and installation, be sure to disconnect the negative (-) terminal of the battery beforehand.**
- **DO NOT route wires where they will get hot, especially in the engine room or where the heater will blow over them.**
If the insulation heats up, it may become damaged, resulting in a short-circuit through the vehicle body.
- **DO NOT install unit where it may obstruct driver's sight or cause possible injury to passengers.**
- **DO NOT allow installation to interfere with normal vehicle operations.**
Make sure that wires will not interfere with moving parts of the vehicle, such as the gearshift, handbrake or seat sliding mechanism.
- **DO NOT connect the ground wire to the bolts and nuts of steering, seat rail, or brake as it may cause accident, fire or electrical shock.**
- **Be sure to use the proper size fuse for replacement.**

Caution for installation

- **Follow the wiring diagram of the product as shown in the manual.**
- **Use provided parts for installation.**
Over-sized hardware or other parts than the one provided may cause an electrical short or result in product not being mounted securely.
- **DO NOT place unit on uneven or unstable surfaces.**
- **DO NOT drop this unit or put pressure on the mirror and display.**

- Cellular phones and remote control starters may cause noise or malfunction to this unit. Please stay away from the unit when using those apparatus.
- This unit contains sensitive components. Please handle your unit safely with care.
- This unit's video format is NTSC. This is not compatible with PAL.
- This unit should not be used in a vehicle where is extremely hot or cold. Please wait until the temperature inside the vehicle becomes normal.
- The height of existing rearview mirror must be 55~80mm to install MM-1. The MM-1 may not be able to be installed when the existing rearview mirror is peculiar shape or there is not enough space between the existing rearview mirror and the interior.
- For driver's safety, proper installation allow the driver to only watch images when the vehicle is stopped and the parking brake is applied. *1
- Do not watch images or the monitor when operating a vehicle.*1
- The LCD panel used in this unit is made with the application of high precision technology. However, there may be minute points on the screen where pixels never light or are permanently lit. Also, if the screen is viewed from an acute angle there may be uneven colors or brightness. Please note that these are not malfunctions but common phenomena of LCDs and will not affect the performance of the monitor.
- The images may not be displayed properly (black and white or unstable images) when the products connected to this unit are not standardized or not functioning properly. Please contact with the dealers or the manufactures of the products for product information.
- Smart Interface must be installed safely with adhesive tape to place where it does not interfere with the vehicle operation.

*1 : Excepting when operating the rearview camera.

Play music



Insert a compact flash facing the label side toward you until you hear a clicking sound.

Press to turn on.

Press to play.

Basic operation

Volume Keep pushing for continuous control.

※ Volume cannot be controlled when using an after market digital processor.
(When selection is D for position setting)

Stop and pause

Pause Press while playing for pause.
Press again to play from where you left off.

Stop Press for stop.

Push for play from the beginning of song you stopped at.

Select songs, Fast-forward, Rewind

· Fast-forward to the next song.

Press once.

· Restart the playing song.

Press once.

· Fast-forward a song.

Press and hold until where you want to listen to and release .

· Rewind a song.

Press and hold until where you want to listen to and release .

Viewing DVD or Navigation system

Input only images to Picture In **AV** on Smart Interface.
 DO NOT input audio or any other signals.
 Images will be played when the vehicle is stopped and the parking brake is applied.
 Play status when songs are playing from the media card will be shown over the images that are input to Picture In.
 Press **PICTURE** to turn the screen off.

Viewing images of rearview camera.

Input images from rearview camera to Picture In **CAMERA** on Smart Interface.
 Connect the wire used to activate the back up lighting system (12V) to **BACK** on Smart Interface.
 The images from the rearview camera will be shown when the vehicle is put into reverse.

*Play status will not be shown over the rearview camera image.
 The unit will power on automatically and shows the image from the rearview camera when the vehicle is put into reverse.
 The images from the rearview camera have priority over the images input into the **Picture In AV**.

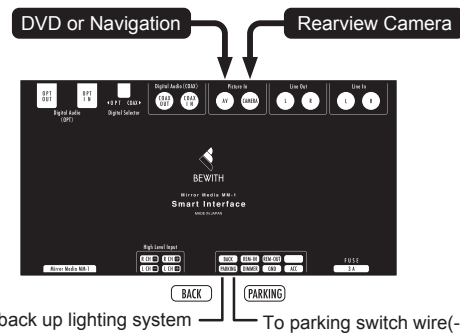

Installing the unit over the existing rearview mirror.

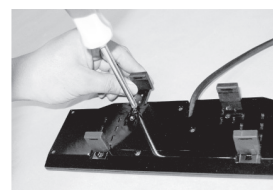

Adjust the two upper brackets to the shape of the existing mirror using a screwdriver.

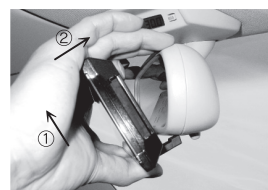

① Apply two bottom sliding brackets to the bottom of the existing mirror.
 ② Pull unit carefully upward until upper brackets lock on to top part of the mirror.



Make sure the unit is properly mounted.

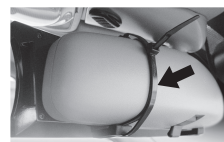

※ The enclosed wire ties may be used to further increase the stability and security of the MM-1 to the factory installed rearview mirror.

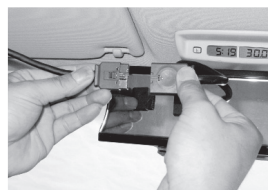

Connect cables.

Compatible media (not included)

MM-1 accepts CF standard compact flash Type I and Type II. Media capacity must be up to 4GB.
 Use adapter for other media cards.

※ We recommend to purchase the compact flash at where you purchased the MM-1 or bewith authorized dealer.
 Compare to compact flash which has flash memory, micro drive may not be suitable for inside the vehicle where it cannot avoid shock and vibration.

Download music to media card.

MM-1 can play music data(WAV/MP3) downloaded from a computer. Music data files must be copied and pasted or dragged and dropped on to the top level folder in the media card.

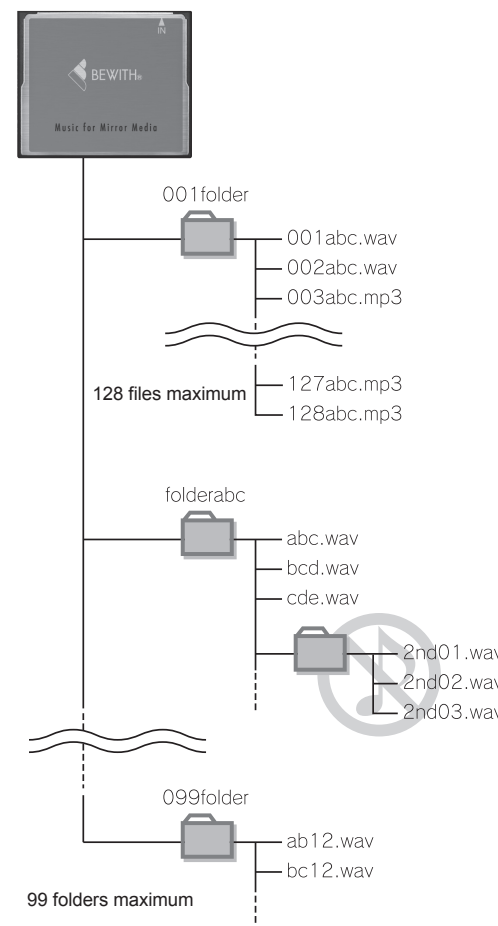

How to name folders and music data files

Name each folders and music data files with alphabets and numbers.

Ex) Folder

airtst01.....

Maximum 99 characters with alphabets and numbers

※ First 8 characters of folder name made with computer will be shown on MM-1 display. More than 9 characters of the folder name are not shown on display while the music is playing.

Ex) Music data file

002abc..... wav (or WAV)

Maximum 99 characters with alphabets and numbers an extension

002abc..... mp3 (or MP3)

Maximum 99 characters with alphabets and numbers an extension

※ The dot(.) in front of an extension of the folder and music data file name and the extensions like wav and mp3 are not shown on MM-1.

Folders and files are played by alphabetical order. Numbers have priority over the alphabets when those names include both numbers and alphabets. Music data files that are not in the folder are not played. Music data files that are in the second level of folder are not played. Maximum 99 folders, 128 files in each folders can be saved. Any other languages except alphabets and numbers are not shown. Each MP3 tag is not displayed on the MM-1. Video file cannot be played on the MM-1.

Usage restriction

Recorded music you make is for your personal, non-commercial, use only. We are not responsible for damage or elimination of music data saved on memory card caused by malfunction of this unit.

Menu

● Menu display



Press **MENU** to display menu.
Press **MENU** one more time to close menu.
Press **▲** **▼** to scroll each contents.
Press **ENTER** to select each contents and go to setting screen.

● Dimmer setting

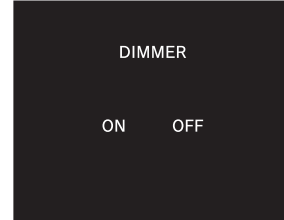

Press **◀** **▶** to chose ON or OFF.
Choose ON to dim the screen.
Choose OFF to dim the screen only when the vehicle illumination is on.
Press **ENTER** after choosing ON or OFF to go back to menu screen.

● Color setting



Press **◀** **▶** to adjust the color.
Adjustable color range is -010~-001, 0, +001~+010.
Press **ENTER** after the adjustment to go back to menu screen.

● Brightness setting

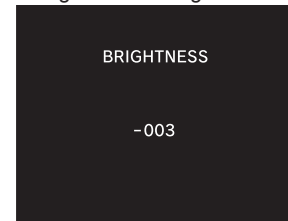

Press **◀** **▶** to adjust the brightness.

Adjustable brightness range is -010~-001, 0, +001~+010.

Press **ENTER** after the adjustment to go back to menu screen.

● Position setting

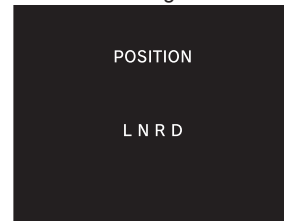

Use this menu to set the listening position or change the digital system.
Press **◀** **▶** to change the setting.

(Analog output)
L Left seat position
N Normal position
R Right seat position
(Digital output)
D Digital position(Choose this position when using digital out on smart interface)

Press **ENTER** after the adjustment to go back to menu screen.

● Reset

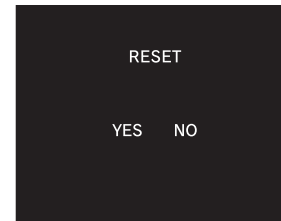

All menu setting will be reseted to initial setting.
Press **◀** **▶** to choose Yes or No.
Press **ENTER** after choosing Yes or No to go back to menu screen.

< Initial setting >
DIMMER - OFF
COLOR - 0
BRIGHTNESS - 0
POSITION - N

OSD

Press **FOLDER** to display the folder screen.

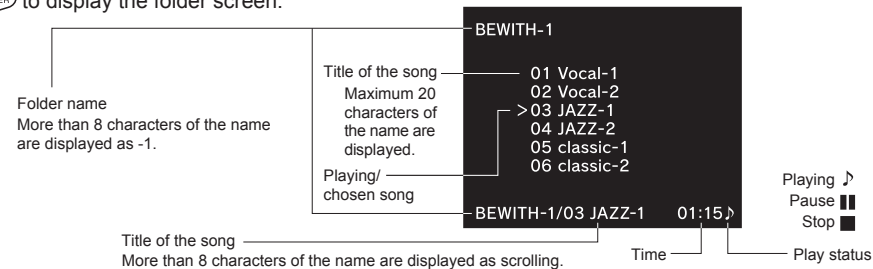

Display change

Play status display is changed when pressing **DISPLAY** each time from regular display.

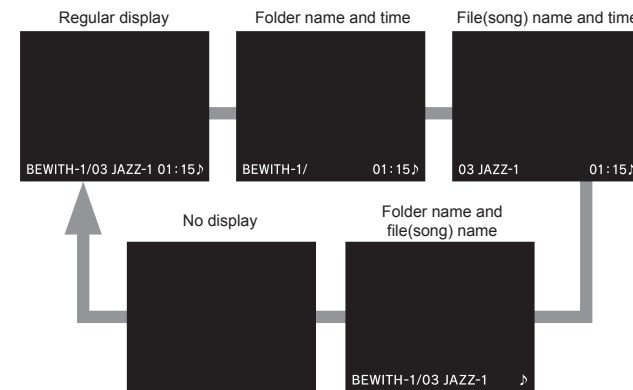

※ Volume setting, changing songs, and other setting display will be shown for about 5 seconds and disappeared while No display is chosen.

Display ON/OFF

Display will be on and off as pressing **PICTURE** each time.



Folder change and file(song) select Direct song selection

Press **FOLDER** to display the folder screen.



Press **◀** **▶** to scroll the folders.

Choose the folder that has the songs you like to listen to.

Press **ENTER** to choose the song and play.

Repeat, Random play

Press **REPEAT** **RANDOM** to change the play method while playing.

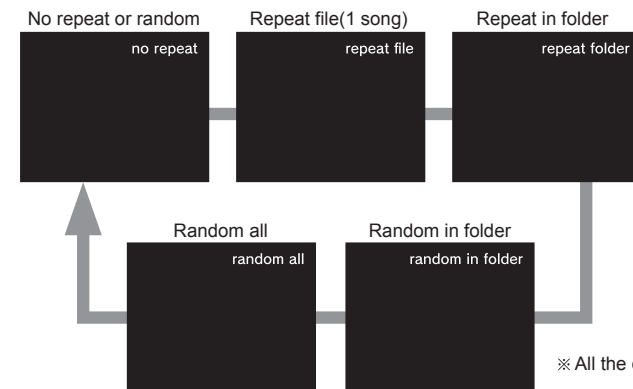

※ All the display will be disappear in about 5 seconds.

Connecting MM-1

Connecting with factory standard system(1)

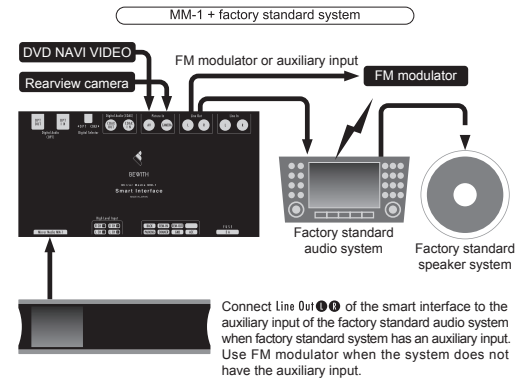

Connecting with factory standard system(2)

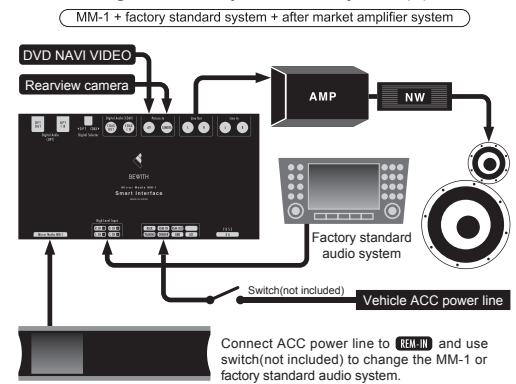

Connecting with factory standard system(3)

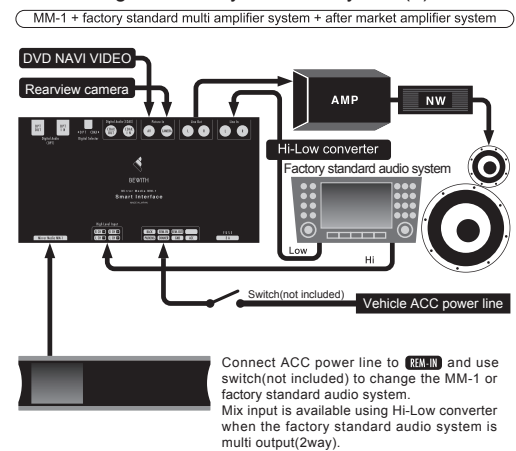

Connecting with after market system(1)

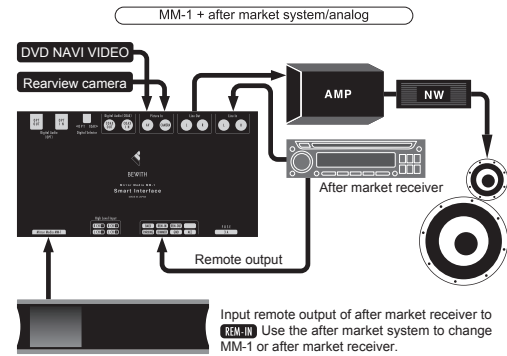

Connecting with after market system(2)

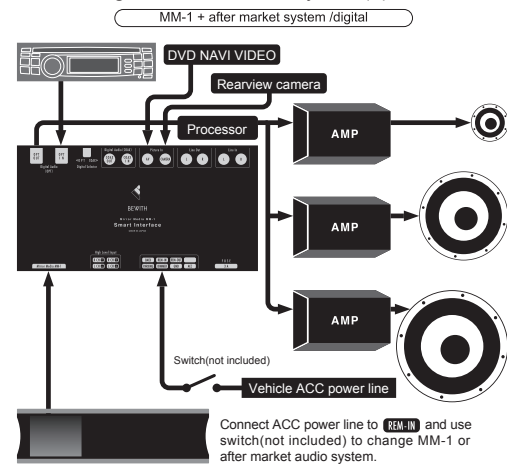

Important) Use switch(not included) to change MM-1 and other system(factory standard or after market audio system). Volume can be controlled by each system. Please make sure the right installation in your vehicle at Bewith authorized dealer.

Basic connection of smart interface

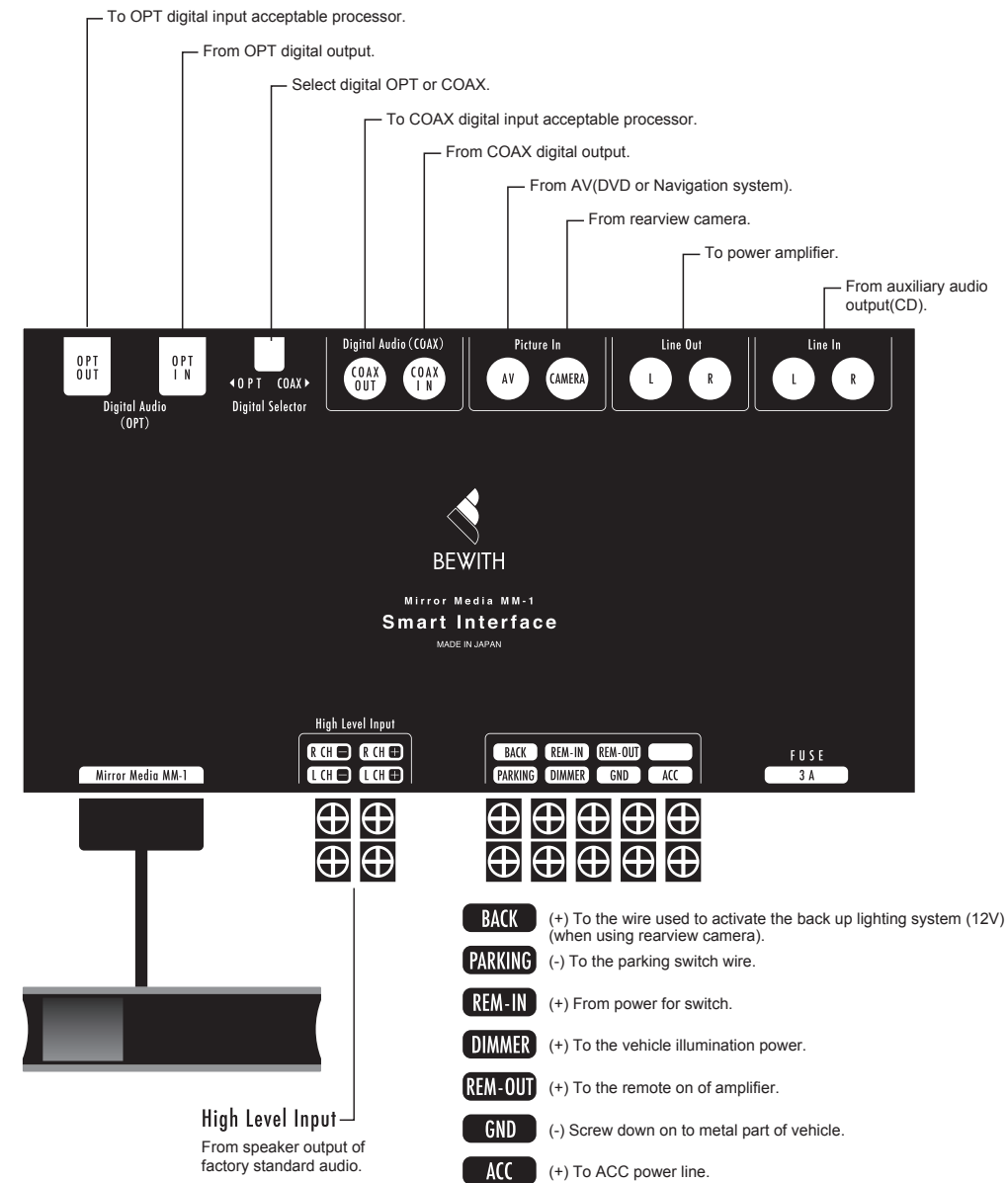

Important) Do not need to connect MM-1 to the battery power-line. MM-1 does not have power on switch on itself according to its low power consumption design.(Remote control has power on and off switch) In case of connecting ACC to the battery power-line, MM-1 would keep the power on and also all other machineries (like power amplifier) connected to MM-1 keep the power on and may cause battery discharge.

Remote control

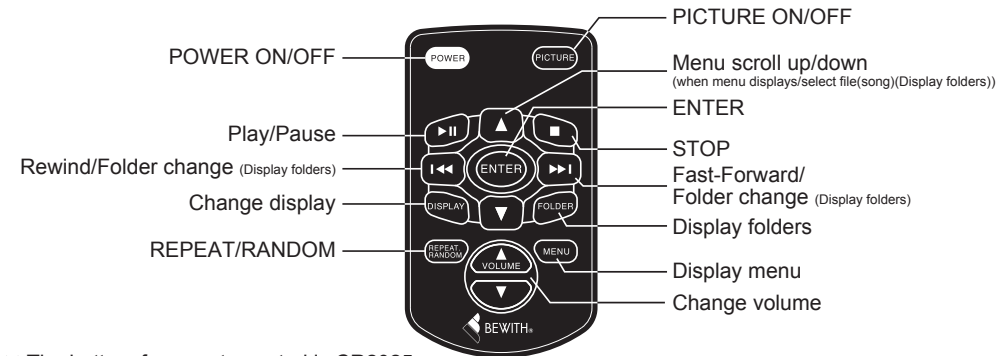

* The battery for remote control is CR2025.

How to change the battery

1. Insert the tip of the pen into the slot of battery case and pull down toward an arrow mark.

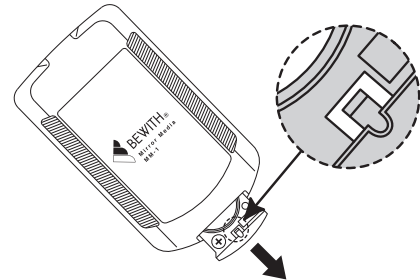

2. Place the battery "+" facing down.

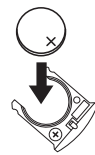

3. Push battery case into remote control until clicks.

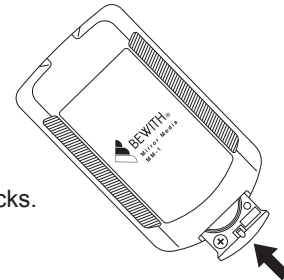

Warning for safe usage of remote control

- Do not expose remote control to direct sunlight or high temperature.
- Face the remote sensor toward MM-1's remote sensor window for control.
- Direct sunlight will not enable the remote control to work properly.
- Do not charge remote control battery. It may cause the battery fluid discharge.
- If battery fluid discharges, clean the battery fluid and replace a new battery.
- Replace the battery to a new battery when the remote control operates slowly.

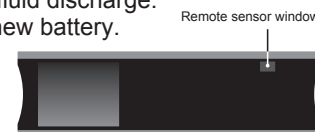

Components

- MM-1 x 1
- Smart Interface x 1
- Cable x 1
- Cable tie x 2
- Owner's Manual x 1

